

BATTERY BACKUP SYSTEMS



Dimensions



Installation and Start-Up Manual
for Dimensions model 24M11-WBE
122182 (10/06/11 Revision 1.1)

Table of Contents

Table of Contents.....	2
1.0 Introduction.....	3
2.0 Safety Instructions.....	4
2.1 Warning and Danger Symbols:.....	4
2.2 Battery Backup System (BBS) Precautions:.....	4
2.3 Battery Precautions:.....	4
3.0 BBS Physical Description.....	6
3.1 LCD Panel Description:.....	7
3.2 LCD Contrast Adjustment.....	7
3.3 Dry Contact Relay Information.....	7
3.4 Main Sub Screens.....	8
3.5 Keypad and LED's.....	9
3.6 Bypass Switch - 511020-2 (Closed Back).....	10
3.7 Bypass Switch 511020-1 (Open Back).....	10
4.0 Installation.....	11
4.1 BBS Components:.....	11
4.2 Recommended Tools for Installation:.....	11
4.3 Mounting the BBS.....	12
4.3.1 Mounting the BBS Module:.....	12
4.3.2 Mounting the Manual Bypass Switch.....	13
4.3.3 Mounting the Batteries.....	13
4.4 Overall Wiring Diagram.....	16
4.5 Wiring the BBS.....	17
4.5.1 Wiring Overview.....	17
4.5.2 Combo Bypass Switch (511016-1 or 511016-2) Wiring.....	17
4.5.3 Temperature Compensation Cable Wiring.....	17
4.5.4 Dry-Relay Contact Wiring.....	18
4.5.5 Self Test.....	18
4.5.6 External Fan.....	18
5.0 Start-Up.....	19
6.0 Adjustments.....	20
6.1 Sense Type.....	20
6.2 Transfer Points.....	20
6.3 Timer Relay.....	20
6.4 Low Battery Relay.....	20
7.0 Communications ~ Ethernet.....	21
7.1 Direct Connection.....	21
8.0 Communications ~ RS-232.....	23
8.1 Connecting the RS-232 Port.....	23
8.2 Terminal Setup.....	23
8.2.1 HyperTerminal Setup.....	23
8.2.2 HyperTerminal Log File.....	25
8.2.3 Other Terminal Emulation Setups.....	25
8.3 Using the BBS Communication Interface.....	26
9.0 Maintenance.....	28
9.1 Preventive Maintenance:.....	28
9.1.1 BBS Module Maintenance:.....	28
9.1.2 Battery Maintenance:.....	28
9.2 Alarms & Faults.....	29

1.0 Introduction

Thank you for purchasing a Dimensions Battery Backup System (BBS) from Sensata Technologies! We think that you will find this product to be extremely reliable and easy to use. We have put a lot of time and resource into this system to make it a product that you will be completely satisfied with.

Please read this manual completely, before installation and operation. Please see the “Operation” manual for detailed operation instructions.

Contact us by phone or email if you need assistance with this product.

We can be reached at:

1-800-553-6418

<http://dimensions.sensata.com>



inverterinfo@sensata.com

2.0 Safety Instructions

Important: Read this manual before installation, it contains important safety, installation, and operating instructions. Save this manual and keep it in a safe place.

2.1 Warning and Danger Symbols:

To reduce the risk of electrical shock and to ensure the safe operation of your Dimensions power inverter, the following symbols are used throughout the manual.

ATTENTION:  Important operating instructions. Follow them closely.	DANGER:  Risk of personal harm and/or electrocution exists in this area. Use extreme caution.
---	--

2.2 Battery Backup System (BBS) Precautions:

- BBS produce hazardous voltages. To avoid risk of harm or fire, the unit must be properly installed.
- There are no user serviceable parts inside, do not remove the cover.
- The BBS should not be mounted in a location that may be exposed to rain or spray.
- The BBS should not be installed in a zero clearance enclosure.
- Damage to the BBS will occur if correct polarity is not observed when installing the DC input cables.
- Damage to the BBS will occur if an external AC power source is applied to the inverter's AC hardwire output.
- The BBS contains a circuit breaker and capacitor that may produce a spark. Do not mount in a confined battery or gas compartment.

2.3 Battery Precautions:

Battery Emergency Instructions



If you get splashed with electrolyte from the battery, immediately wash the affected area with water. If electrolyte gets into your eyes, wash your eyes for at least 10 minutes with clean running water or a special neutralizing eye wash solution. Get medical help immediately.

If there is an electrolyte spill, it can be neutralized by using a battery “spill kit” or a solution of 1lb. of baking soda in 1 gallon of water.

NOTE: Battery installation and service is to be done or supervised by personnel trained in battery safety and precautions.



- **CAUTION:** Working in the vicinity of lead-acid batteries is dangerous. There is a risk of acid exposure.
- **CAUTION:** Batteries generate explosive Hydrogen gases during operation. Never expose the BBS, or the enclosure to open flames or sparks to prevent a fire or explosion.
- **CAUTION:** There is risk of high current discharge from shorting a battery that can cause fire and explosion. Use insulated tools during installation.
- **CAUTION:** Remove all rings, watches, jewelry or other conductive items before working near the batteries.
- **CAUTION:** Dispose of the batteries according to local regulations. Do not incinerate batteries; risk of explosion exists.
- **CAUTION:** Disconnect charging source prior to connecting or disconnecting wires to the battery terminals.
- **CAUTION:** Never let live battery wires touch the BBS, the enclosure, or any metal objects. Fire and/or an explosion could result.
- **CAUTION:** Ensure proper polarity when wiring the batteries to the battery cable assembly. Red wires connect to the (+) Positive post and Black wires to the (-) Negative post. Keep the battery set wires paired to each battery as shown in the installation manual. Incorrect wiring can cause a fire or an explosion.
- **CAUTION:** Ensure proper connections from the cable assembly to the batteries. Do not connect the cable assembly to itself or a battery directly to another battery - or a fire or explosion could result.
- **CAUTION:** Risk of explosion if battery is replaced by an incorrect type. Always replace batteries with the same type, model number, and electrical ratings.
- Inspect the batteries once a year for cracks, leaks or swelling.
- Batteries that are in storage should be charged at least once every three months for best performance and lifetime.

3.0 BBS Physical Description

Front Panel

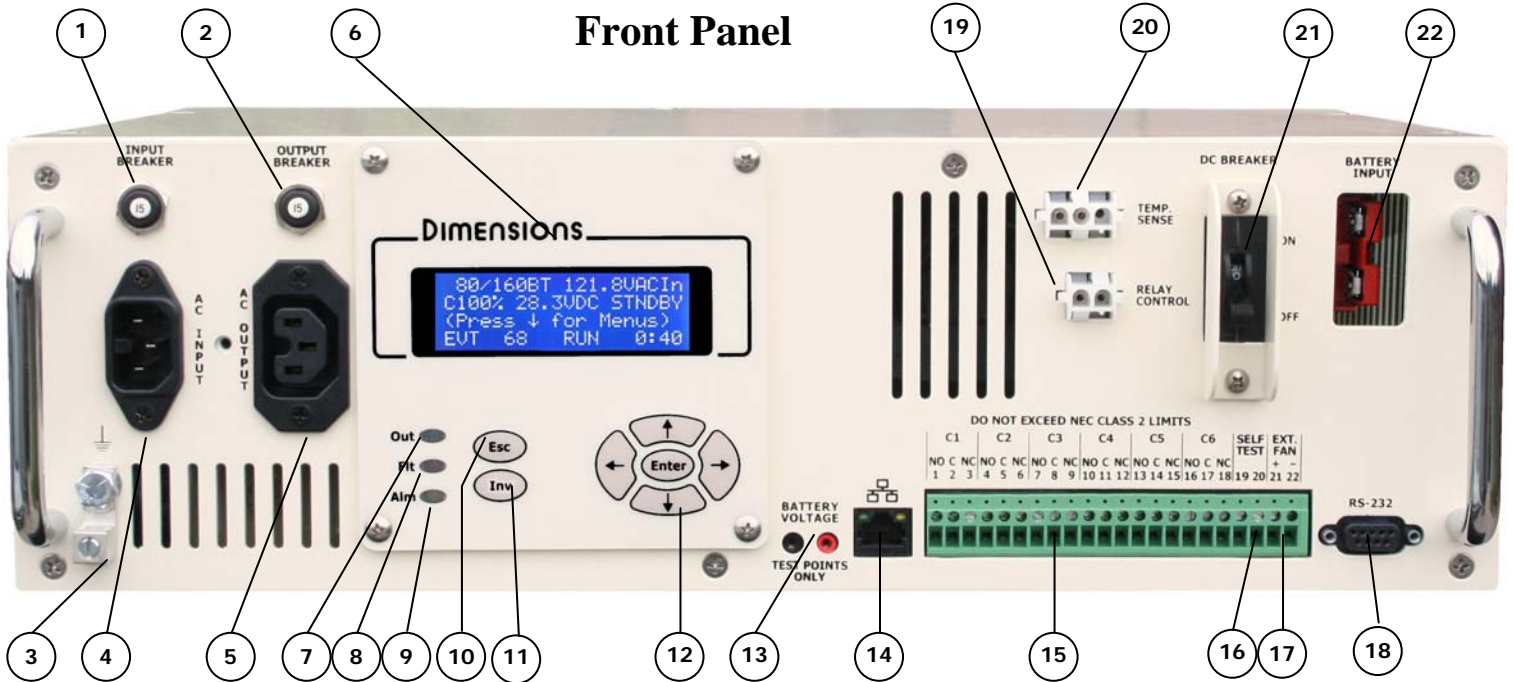

1. **Input Breaker:** This circuit breaker provides input protection.
2. **Output Breaker:** This circuit breaker provides output protection.
3. **Ground Lug:** Connect to chassis ground.
4. **AC Input:** This connects to the Bypass Switch.
5. **AC Output:** This connects to the Bypass Switch.
6. **LCD Panel - Rotatable:** Provides Status and Configuration information. Rotate for vertical mounting.
7. **Output LED:** Green LED lights to show that the BBS is providing AC output.
8. **Fault LED:** Red LED lights to show that there is a fault condition. See the LCD to see what the “fault” is (PROBE FLT, short circuit, batt. Low cut off, batt. volt. high, output volt. high, bbs temp. high, overload excessive or bbs failure).
9. **Alarm LED:** Yellow LED lights to show that there is an alarm condition. See the LCD to see what the “Alarm” is (temp. low, temp. high, check battery, overload, output volt. low, ac line freq. L or h).
10. **Esc Key:** Used to “escape” out of menu screens and settings.
11. **Inv Key:** Used to turn the inverter function “On” or “Off”.
12. **Navigation Keys:** Use these keys to easily navigate through the menu system.
13. **Battery Voltage Test Points:** Test jacks for measuring the battery voltage at the BBS.
14. **Ethernet Connector:** Connect to your network switch or laptop. Built-in web browser interface.
15. **Programmable Dry Relay Contacts:** These contacts are used to bring the cabinet to “Flash”, send alarms, and other functions.
16. **Self Test Contacts:** Shorting these contacts initiates the self test feature.
17. **Ext. Fan:** Can drive an external 24 VDC fan for cabinet cooling.
18. **RS-232 Port:** Connects to a PC for monitoring and controlling the BBS.
19. **Transfer Relay Connector:** Two-pin connector that connects to the Bypass Switch.
20. **Temp. Comp. Sense Connector:** Three-pin connector that connects to the 9 foot battery temperature compensation sense cable.
21. **DC Breaker:** This circuit breaker provides input protection.
22. **Battery Connector Cable:** Two-pin connector that connects to the battery cable assembly.

3.1 LCD Panel Description:

Our menu system makes it easy to get status information and to configure. The most commonly requested status information is readily available on just two screens. See the detail below for more information.

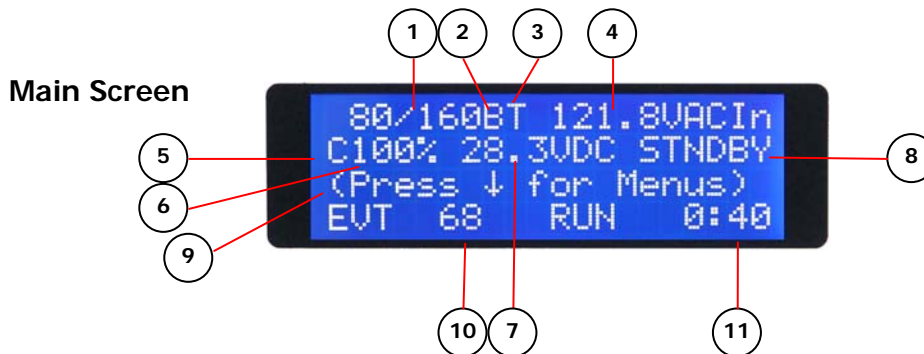

- (1) **Transfer Points:** Currently configured transfer points that are in use. These will change as the “Sense Type” option is changed.
- (2) **Sense Type:** Current transfer point option enabled. “N” = normal, “G” = generator, “B” = Buck/Boost.
- (3) **Time of Day Program:** The “T” will be visible if this program is enabled.
- (4) **AC Input Voltage:** AC input voltage coming from the utility.
- (5) **Charger:** The “C” will be visible when the charger is on.
- (6) **Battery Charge:** The current capacity of the battery.
- (7) **Battery Voltage:** Battery system voltage.
- (8) **BBS Mode:** Mode that the BBS is in. Modes are; “STNDBY”, “BACKUP”, “BOOST1”, “BOOST2”, “BUCK1”, “BUCK2”, “SELF TST”, and “INVOFF”.
- (9) **Information Line:** Prompts for menus. Also displays any relay status, fault and alarm information. Control the speed of the scroll by using the left arrow key to slow down and the right arrow key to speed up.
- (10) **Event Counter:** The number of times that the inverter has come on since the last time the counter was reset. Pressing both the right and left arrow keys simultaneously will reset both the event counter and the run time meter (This will also reset the Buck and Boost meters on the “Main – Sub Screen 2”).
- (11) **Run Time Meter:** The total amount of time the inverter has been on since the meter was last reset. Pressing both the right and left arrow keys simultaneously will reset both the “Backup” event counter and the run time meter (This will also reset the Buck and Boost meters on the “Main – Sub Screen 2”).

3.2 LCD Contrast Adjustment

The LCD will automatically adjust its contrast by the temperature of its environment. You can adjust this setting by pressing the “Enter” key while at the main screen. Simply press the “Up” key to brighten or the “Down” key to darken and then press enter to save your configuration.

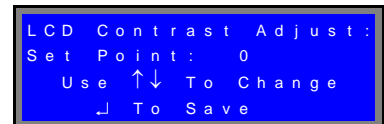

3.3 Dry Contact Relay Information

The third line of the LCD will inform you of the status of energized relays. For example, this screen shot shows that there are two relays energized by the “On Batt” or backup condition. The two relays that are energized are relays C1 and C2 as indicated by the “1” and “2” under the word “BACKUP.”

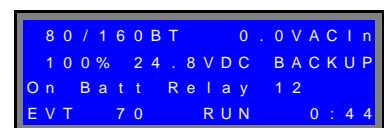

3.4 Main Sub Screens

Pressing the “Up” arrow will take you to a second status screen

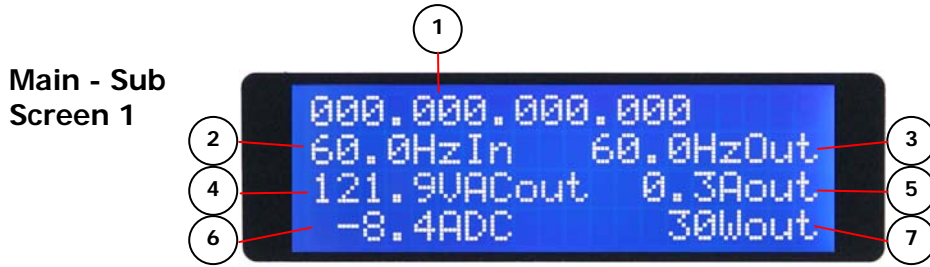

- (1) **IP Address:** This is the currently configured IP address of the BBS.
- (2) **Frequency In:** Frequency of the utility power coming in.
- (3) **Frequency Out:** Frequency of the power coming out of the BBS.
- (4) **Voltage AC Out:** Output voltage of BBS.
- (5) **Amps AC Out:** Output current of BBS.
- (6) **Amps DC Out:** Output charge current to batteries.
- (7) **Watts Out:** Output wattage of BBS.

Pressing the “Up” arrow again will take you to the Buck & Boost Counter screen



- (1) **Buck Event Counter:** The number of times that the BBS has been in Buck mode since the last time the counter was reset.
- (2) **Buck Run Time Meter:** The total amount of time the BBS has been in Buck mode since the meter was last reset.
- (3) **Boost Event Counter:** The number of times that the BBS has been in Boost mode since the last time the counter was reset.
- (4) **Boost Run Time Meter:** The total amount of time the BBS has been in Boost mode since the meter was last reset.



Pressing both the right and left arrow keys simultaneously will reset all of the event counters and the run time meters (Inverter, Buck, and Boost).

3.5 Keypad and LED's

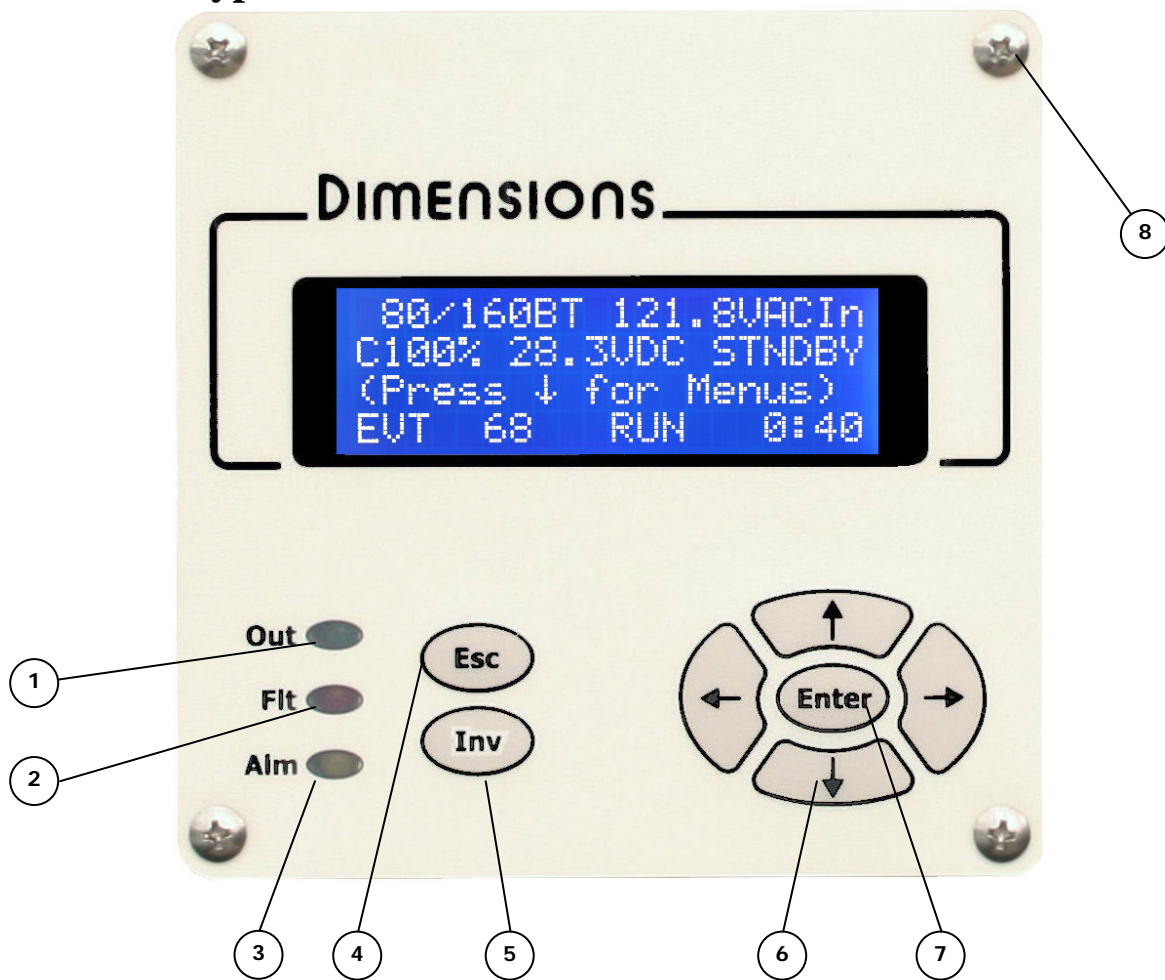

- (1) **Output LED (Green):** This LED will be on any time the BBS is providing output to the load. The operating modes that this can occur are: “BACKUP”, “BUCK1”, “BUCK2”, “BOOST1”, AND “BOOST2”.
- (2) **Fault LED (Red):** This LED will be on any time that the BBS has detected a “Fault”. Look at the third line of the LCD for information on the fault.
- (3) **Alarm LED (Yellow):** This LED will be on any time that the BBS has detected an “Alarm”. Look at the third line of the LCD for information on the alarm.
- (4) **Esc key:** This key is used to escape from changing settings and to jump to higher menus.
- (5) **Inv key:** By pressing this key you can enable or disable the inverter of the BBS.
- (6) **Navigation keys:** Press these keys to navigate through the menu system. You also use these keys to change values in the “Configuration” and “System” menus.
- (7) **Enter Key:** Pressing the “Enter” key will take you into menus and allow you to change and save settings.
- (8) **Rotatable Display:** Remove these four screws to rotate the display for vertical mounting.



Pressing both the right and left arrow keys simultaneously will reset all of the event counters and the run time meters (Inverter, Buck, and Boost).

3.6 Bypass Switch - 511020-2 (Closed Back)

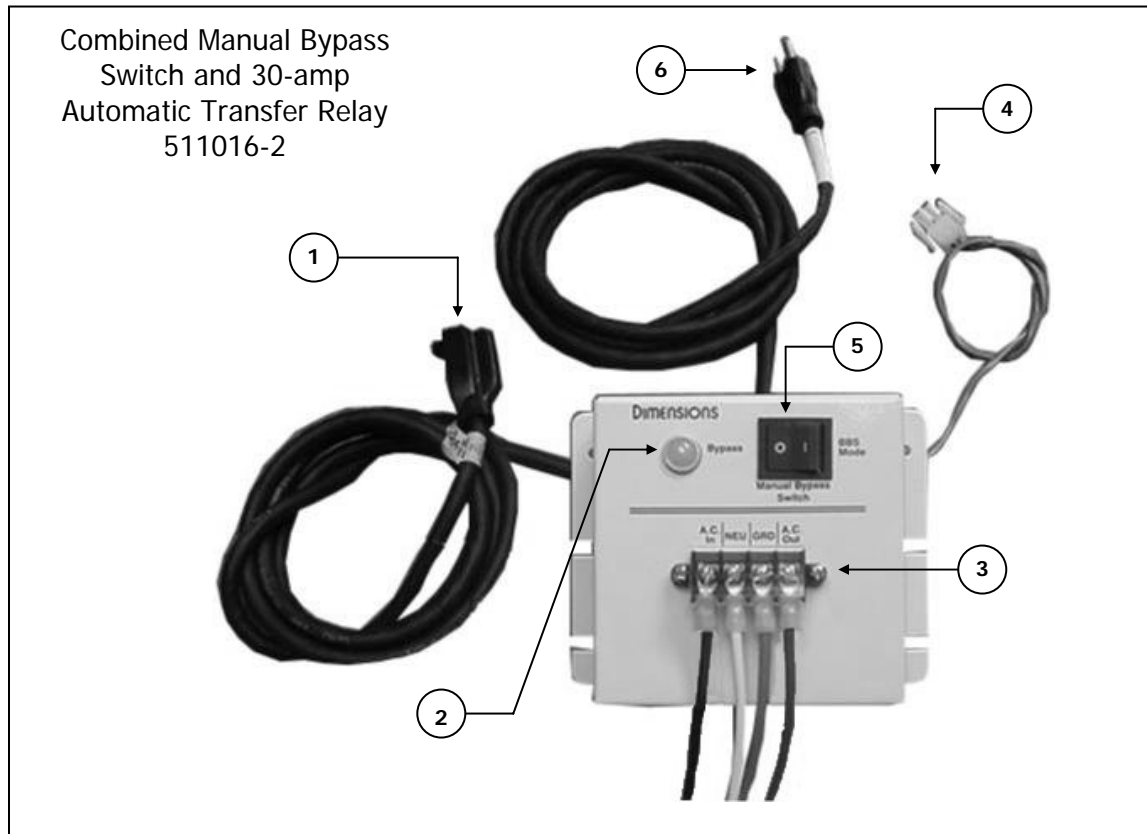

- (1) **AC Output Cord:** Connects to BBS AC Input cord.
- (2) **Bypass Indicator:** Lights to indicate the switch is in the bypass mode.
- (3) **Terminal Board:** AC Wiring connector board
- (4) **Transfer Relay Connector:** Connects to connector on BBS to drive the 30-amp relay.
- (5) **Bypass Switch:** Used to isolate the BBS system from external AC power during routine maintenance.
- (6) **AC Input Plug Cord:** Connects to BBS AC Output cord.





3.7 Bypass Switch 511020-1 (Open Back)

The function and features of the 511020-1 open back are the same as the 511020-2 closed back.

4.0 Installation

4.1 BBS Components:

TABLE 1

Picture	Part Number and Description	Qty.
	24M11-WBE	1
	Combined Manual Bypass Switch – 30A Automatic Transfer Relay 511020-1 (open back panel) or 511020-2 (enclosed case).	1
	Use this Cable Stay to keep your AC Input and AC Output cords locked in place.	1
	12 VDC, 79 AH Group 24 AGM batteries 390003 or 12 VDC 105 AH group 31 batteries 390006 are available. One quick connector battery cable assembly included with each BBS.	4 Batt's 1 Cable

4.2 Recommended Tools for Installation:

Butt type and insulated connectors, drill, crimpers (for insulated and non-insulated connectors), digital volt meter with probes (true RMS), electrical tape, #2 Phillips screwdriver, wire cutters, wire strippers, cable ties, and tape measure.

4.3 Mounting the BBS

4.3.1 Mounting the BBS Module:

1) **Shelf Mounting:** Mounting brackets are not required, but can be ordered as an option. Mount brackets to the side of the BBS using supplied 10-32 screws. Mount assembly to the shelf using ¼-20 hardware.



Shelf Mount Brackets - #141418 (Set – Left and Right)

2) **Rack Mounting:** The BBS may either be mounted on our shelf brackets or with our mounting ears. The ears may be attached to either the front or the rear of the unit.



Ears - #141397 (Set – Left and Right)



Shelf Brackets - #141271 (Set - Left & Right)

4.3.2 Mounting the Manual Bypass Switch

- Locate the cabinet support (Rack mounting – check for left mounting) or shelf (Shelf mounting).
- Using the screws and washers provided mount the combined manual bypass switch as shown below.

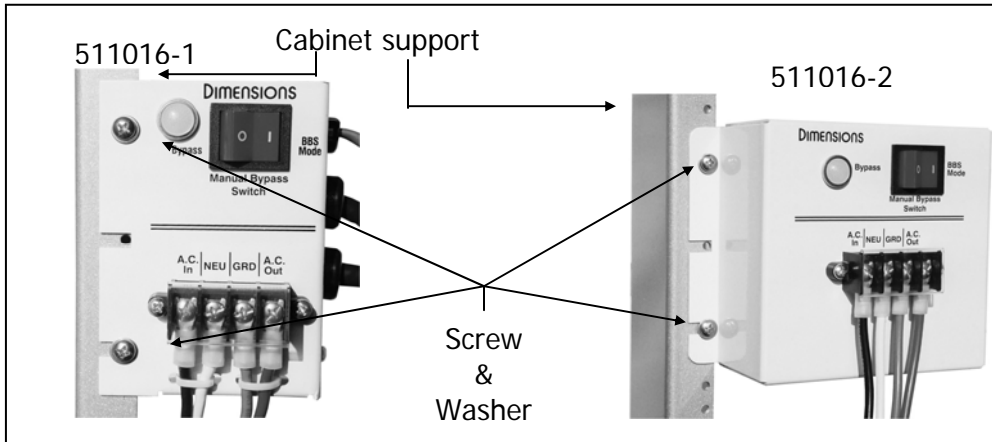

Mounting the CMBPS-30ATR open and closed case

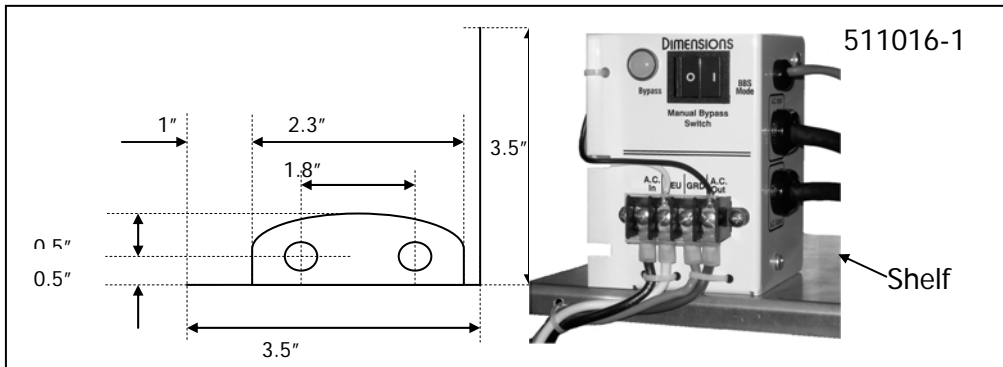

CMBPS-30ATR open case shelf mounting and footprints

4.3.3 Mounting the Batteries



Warning: Connecting the BBS incorrectly to the batteries will cause damage that is not covered under warranty.

- Refer to Figure 1, Page 14. Using one of the four quick connector wire sets provided connect the red wire to the positive post of the first battery. Connect the black wire to the negative post of the same battery.
- Repeat the procedure on the second, third and fourth battery respectively. Connect the temperature compensation sense cable probe ring lug to a negative battery post. Refer to Figure 2, Page 15.
- Check the tightness of all connections
- Connect the four quick connectors as shown on Figure 2.

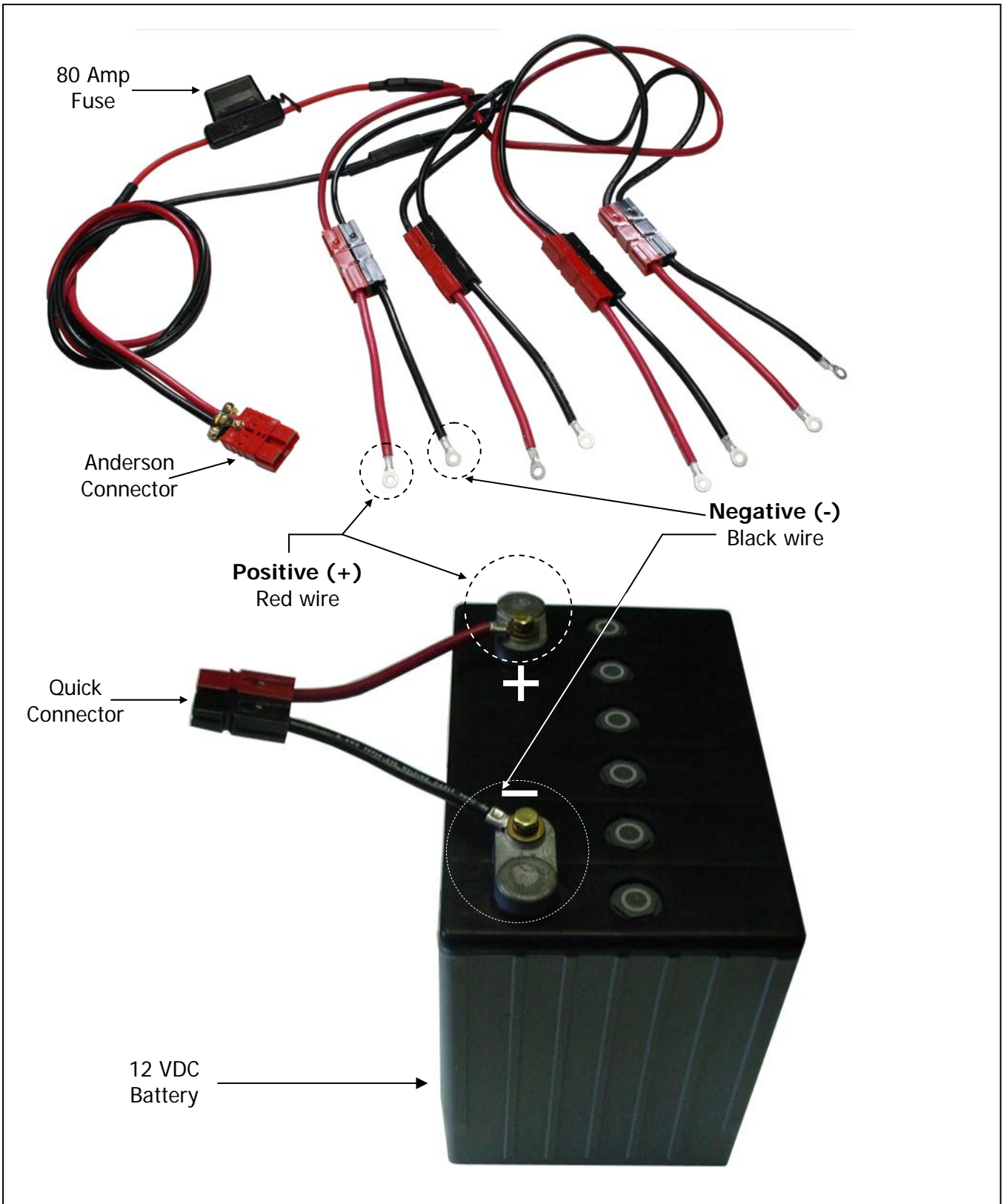

FIGURE 1: Battery wiring

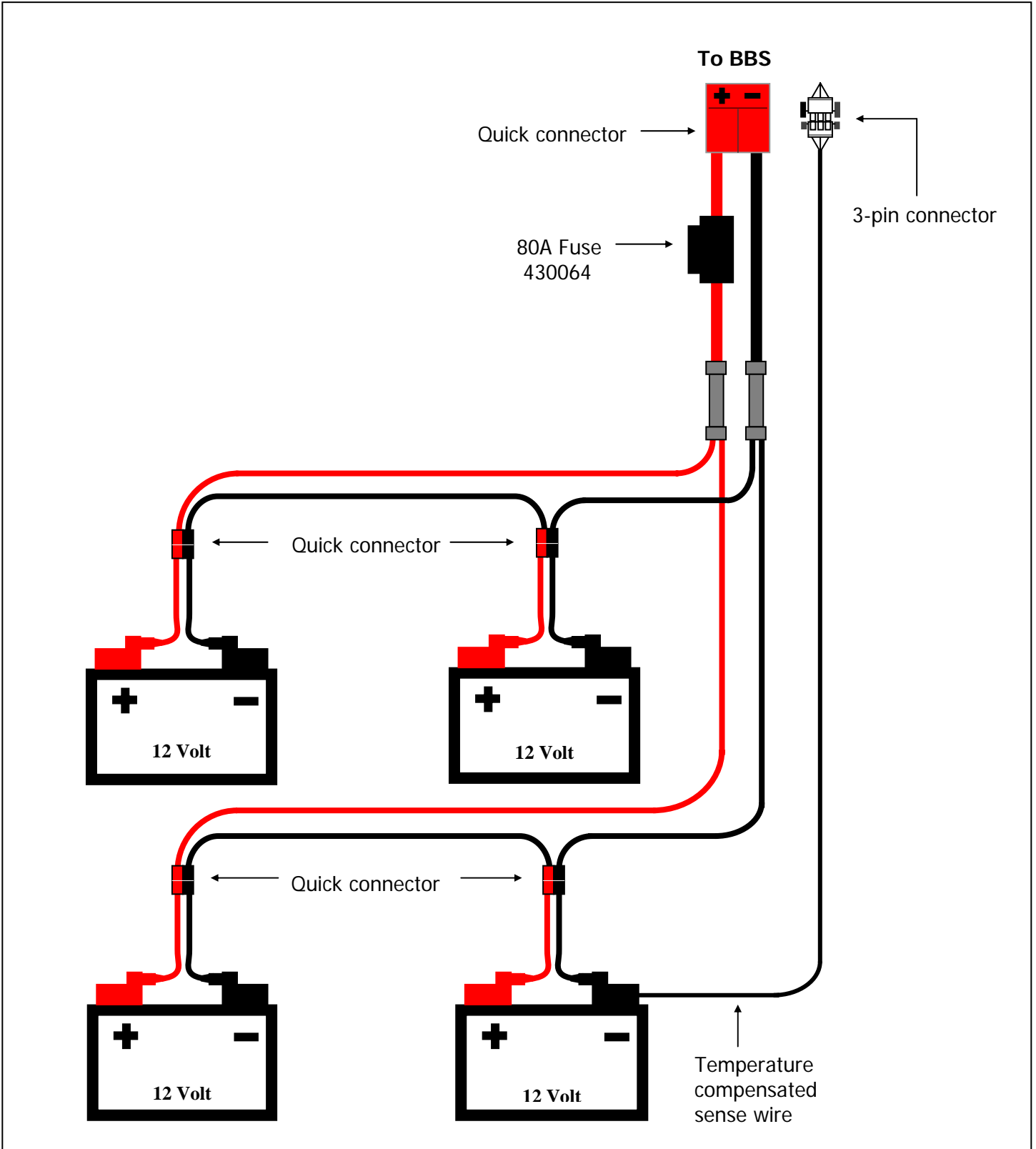
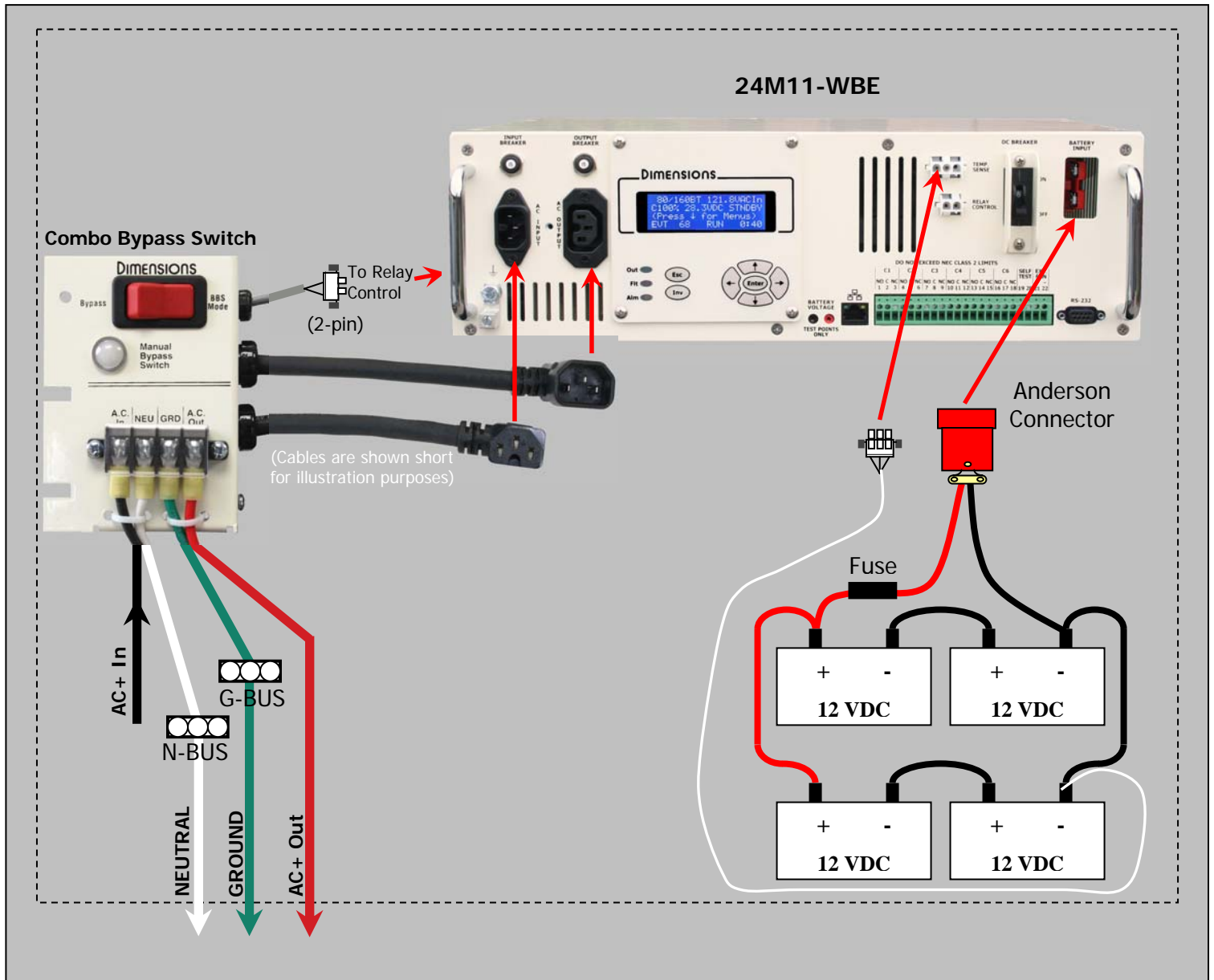

FIGURE 2: 24Vdc Battery wiring configuration

4.4 Overall Wiring Diagram

Overall Wiring Diagram



4.5 Wiring the BBS

4.5.1 Wiring Overview

- 1) Wire the bypass switch to the utility and signal cabinet (bypass switch is in “Bypass” position).
- 2) Connect the black AC cords from the bypass switch to the BBS. Use the Cable Stay shown in Figure 3 below.
- 3) Connect the gray 2-conductor cable from the bypass switch to the BBS.
- 4) Connect the gray 3-conductor cable from the batteries to the BBS.
- 5) Connect the red DC battery connector to the BBS (THIS IS PART OF THE START-UP PROCEDURE).



Figure 3:

4.5.2 Combo Bypass Switch (511016-1 or 511016-2) Wiring

- a) Make sure the external A.C. power is turned “Off”.
- b) Mount the Combined Manual Bypass Switch-30A Transfer Relay (CMBPS-30ATR) in the cabinet. Toggle the Manual Bypass Switch to “Bypass Mode” to isolate the BBS from all AC inputs.
- c) Use the 6½-foot long 10-gauge wires that are supplied for all connections between the controller terminal block and the CMBPS-30ATR. Use the existing utility feed wire when connecting to the CMBPS-30ATR.
- d) Disconnect the A.C. utility line hot (black) wire entering the cabinet. Using the supplied red wire nut, connect the A.C. utility line hot (black) wire to the black 10-gauge wire that is connected to the CMBPS-30ATR terminal labeled “A.C. In”.
- e) Connect the red 10-gauge wire from the CMBPS-30ATR terminal labeled “A.C. Out” to the cabinet A.C. utility line hot terminal disconnected in step “d”.
- f) Connect the CMBPS-30ATR neutral and ground wires to controller grid neutral and ground buss lines respectively.
- g) Connect the A.C. cords with plug and receptacle from the CMBPS-30ATR into the BBS matching receptacle and plug A.C. cords respectively.
- h) Connect the CMBPS-30ATR 2-pin connector plug to the BBS relay 2-pin connector plug.

4.5.3 Temperature Compensation Cable Wiring

Connect the gray 3-conductor cable from the batteries to the BBS. The BBS uses a temperature compensated battery charging system adjusts charge voltage over a range of 2.5 to 4.0 mV/°C per cell.



Make sure that the lug of the temperature compensation cable is connected to the negative post of a battery as shown in figure 9. This is important for proper charging. Do not just let this lug lay in the cabinet disconnected or the batteries will not be charged as per their temperature.

4.5.4 Dry-Relay Contact Wiring

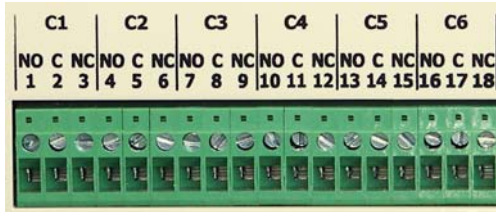

Risk of electrocution may exist when working with the dry relay contacts depending on how your cabinet is interfaced to the BBS. Take necessary safety precautions.

Dry relay connections provide a means for the BBS to bring the cabinet to flash under desired conditions (For example, during a low battery condition). These contacts also allow the controller to indicate various alarm, fault or BBS status conditions. There are 6 relays which are user programmable (C1-C6). The factory default positions of the relays are:

| C1 – On Battery | C2 – On Battery | C3 – Low Battery | C4 – Low Battery | C5 – Timer | C6 – Timer |

Contact rating is 3A/125Vac

Terminal blocks accept 12 to 22 awg wiring, torque is 7 in/lbs

The relays may be programmed to trigger for any combination of the following options:

- On Battery
- Low Battery (set point is adjustable)
- Timer (time is adjustable)
- Time Of Day
- Alarm
- Fault
- BBS Failure
- Disable/Enable

4.5.5 Self Test

By momentarily shorting contacts 19 & 20 together (see above figure), a self test is initiated in the BBS. The test will only occur if the BBS is in “Standby”. The test will run for the duration set in the BBS.

4.5.6 External Fan

A 24VDC cabinet fan may be connected to contacts 21 & 22.

5.0 Start-Up

- a) Verify that all connections are properly made to the Bypass Switch and the BBS.
- b) Turn on the “DC Breaker” on the front panel.
- c) The green output LED should now be on. The LCD will display “Backup”.
- d) Switch the Bypass Switch to “BBS” mode. The BBS will remain in “BACKUP” for 30 seconds as it qualifies the line voltage. The BBS will go into “STNDBY” once the line voltage is qualified.
- e) Press down from the main menu and navigate to the “Configuration” menu. Select your battery type so that the correct charge is applied to your battery string. The default setting is for AGM batteries.
 - a. Then proceed to the next screen to enter your battery size and quantity. This helps the battery percent indicator to reflect capacity based on your battery system. The default setting is 79Ah and 4 batteries. You can skip this part of the setup if this is your configuration.
 - b. The battery percent of charge indicator on the LCD will say “Lrn” (for learning) upon the first power up of the BBS with the battery system. It will show the percent of charge once it has completed the first charge cycle and is in “float” mode.



6.0 Adjustments

The Dimensions Battery Backup System is designed to operate right out of the box without making any adjustments. If you would like to alter settings, please see the common items below or consult the “Operation” manual for more details.

6.1 Sense Type

The BBS has three user selectable modes of sensing the AC input power. These modes are; “Normal”, “Generator”, and “Buck/Boost”. The factory default setting is “Buck/Boost”. “Normal” and “Generator” modes have user selectable transfer points. These two modes have factory preset settings of 100/130 for “Normal” and 95/134 for “Generator”. The “Buck/Boost” setting is not user adjustable and is factory preset for the widest range possible of 80/160. You may select the sense type by navigating to the “Configuration” menu on the LCD.



```
SENSE TYPE :
NORMAL
↑↓ To Scroll Menu
┘ To TOGGLE
```

6.2 Transfer Points

The transfer points for the “Normal” and “Generator” modes are settable by the user. You may adjust the transfer points by navigating to the “Configuration” menu on the LCD. Press “Enter” when you reach the desired transfer point to change (Normal or Generator). You can then change the lower and upper transfer points. The range of adjustment is 89-135Vac.



```
TRANSFER PTS. NORM. :
100 / 130
↑↓ To Scroll Menu
┘ To Change
```

6.3 Timer Relay

The timer setting affects any relay that is configured for “Timer”. The timer will start when the BBS enters Backup mode. Once the BBS has been in Backup for the value of the timer, any relay that is configured for “Timer” will be energized. You may adjust the timer by navigating to the “Configuration” menu on the LCD. The range of adjustment is from 0-480 minutes. The factory default setting is for 120 minutes.



```
TIMER RELAY :
120
↑↓ To Scroll Menu
┘ To Change
```

6.4 Low Battery Relay

The “Low Battery Relay” setting affects any relay that is configured for “Low Battery”. When the BBS is in Backup mode and the capacity of the battery system reaches the set point, any relay that is configured for “Low Battery” will be energized. A dry contact relay programmed for “Low Battery” is typically used to put a cabinet into flash when the battery capacity is low. The range of adjustment is from 0 to 100%. This is adjustable in 5% increments. The default setting is at 40%.



```
LOW BATT. RELAY% :
40
↑↓ To Scroll Menu
┘ To Change
```

7.0 Communications ~ Ethernet

The BBS Ethernet port has many options for use. It can be connected to the Ethernet switch in your signal cabinet or it can be connected directly to your computer. You can access it by your web browser and have it send email notifications. To set up the BBS for communication you will want to contact your IT Administrator to set the Ethernet settings. The settings that you will need to set are listed below:

- BBS IP address
- BBS subnet mask
- BBS gateway
- BBS DNS IP address

Once you have the settings, input them through the “System” menu. You will then be able to connect the BBS to a network switch on your system. When it is connected to your network, you will be able to access the BBS by entering the IP address of the BBS into a web browser of a computer on the network.

7.1 Direct Connection

To connect directly to the BBS after you have set the above parameters, you will need to follow one or both of the instructions listed below depending on your computer’s configuration. You will need an Ethernet “crossover cable” for both instructions. Follow instruction set “A” first:

Instruction Set “A”

1. Connect the crossover cable to both the BBS and your computer
2. Wait one minute as the two devices negotiate the connection
3. Open a web browser and type in the BBS IP address
4. If the page loads, then you are ready to go – if the page does not load, then follow instruction set “B”

Instruction Set “B”

1. Navigate to the “Control Panel” on your PC by clicking “Start” and then click “Control Panel”. Double-click “Network Connections”.

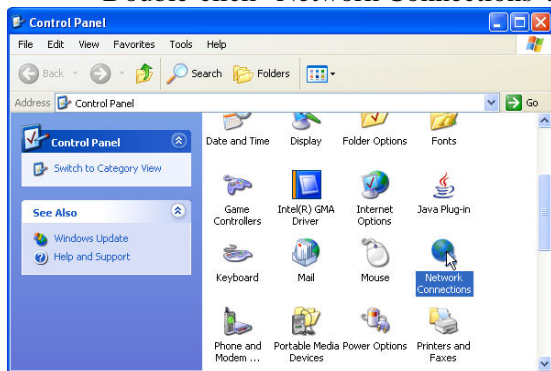

2. Right click on the LAN connection and select “Properties”

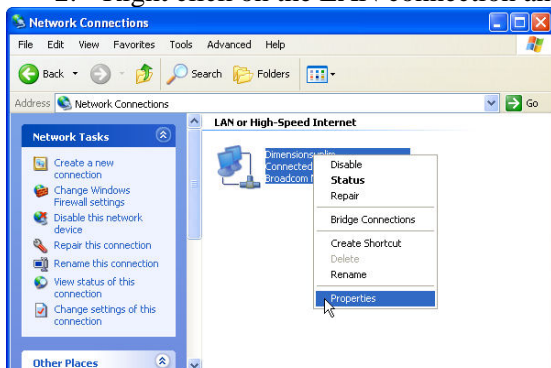

3. Select “Internet Protocol (TCP/IP) and then click “Properties”

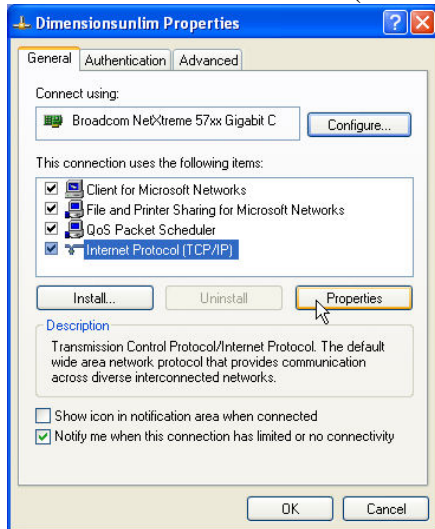

4. Select the “Alternate Configuration” tab. Click “User configured”. Ask your IT Administrator for an IP address that is not being used that you can leave as an alternate setting on your PC. Enter the address in the IP Address and then enter the Subnet mask as shown below. Click “Ok” twice. Disconnect the crossover cable and reconnect.

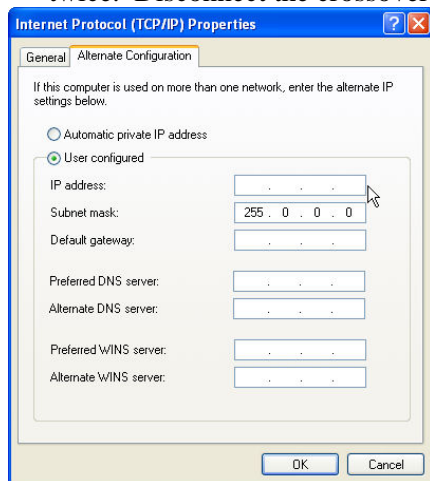

5. Wait one minute as the two devices negotiate the connection
6. Open a web browser and type in the BBS IP address
7. The BBS page should load. If not, check with your IT Administrator.

8.0 Communications ~ RS-232

The front panel has a DB-9 female connector. This port allows the BBS system to be monitored and controlled using HyperTerminal (or other terminal emulation software) on a Windows based PC.

8.1 Connecting the RS-232 Port

Connect a standard RS-232 computer cable between the computer's RS-232 port and the BBS unit's RS-232 port.

8.2 Terminal Setup

8.2.1 HyperTerminal Setup

This section gives step-by-step procedures for configuring the HyperTerminal interface. Before proceeding, the user must determine which PC Com port the BBS is connected to. In this example, Com1 is being used. This will typically be the correct choice for most users and their PC's.

Refer to screen figures 15 through 21:

- 1 From the Windows Start menu go to:
Programs/Accessories/ Communications/HyperTerminal and click the Hyper Terminal entry/icon.
- 2 The *Connection Description* window shown in Figure 15 appears. Enter a name and select an icon for your unit and click **OK**. A sample name appears in Figure 15. When all setup has been completed, this will be the HyperTerminal file name that can be accessed without having to re-initialize the setting.
- 3 The *Connect To* window shown in Figure 16 appears. In the "Connect using" drop-down box select 'COM1' or 'Direct to Com1' and click **OK**.
- 4 The *COM1 Properties* window shown in Figure 16 appears. Set each Port Settings field as shown in Figure 17 and click **OK**.
- 5 The blank terminal interface screen appears as shown in Figure 18. On the File menu go to properties and click once.
- 6 The '**BBS (ADI-24M11 5th & Vine in this case) Properties**' window appears. Click on the **Settings** tab. Fill in the fields as shown in Figure 19. Click the **ASCII Setup** button.
- 7 The BBS (ADI-24M11 5th & Vine in this case) '**ASCII Setup**' window appears. Fill in the fields as shown in Figure 20. Click the **OK** button.
- 8 The '**BBS (ADI-24M11 5th & Vine in this case) Properties**' window reappears (Figure 21). Click the **OK** button.
- 9 HyperTerminal Setup is now finished. The blank terminal interface window reappears as in Figure 18. Press the ENTER key to begin accessing the unit with RS-232 serial communications. The Dimensions BBS interface screen appears as in Figure 21. Go to Section 6.3 to begin using the BBS Communications interface.

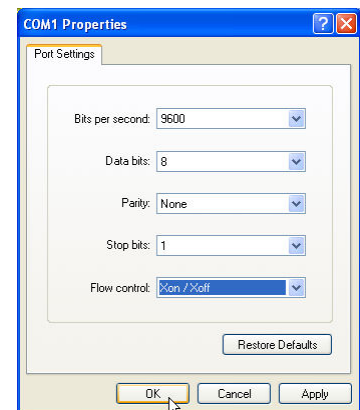

FIGURE 15

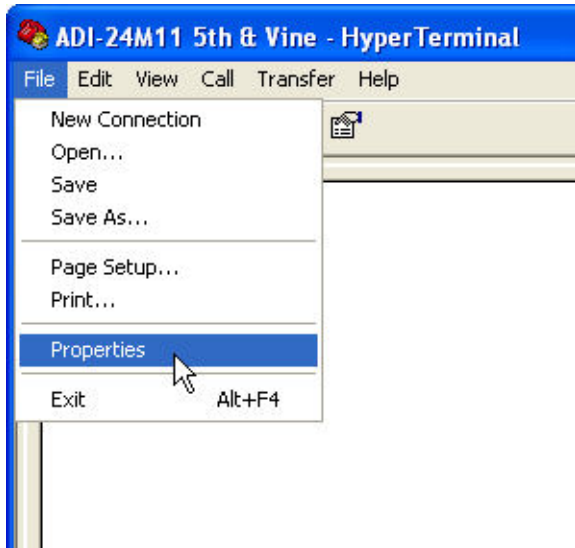

FIGURE 18

FIGURE 16

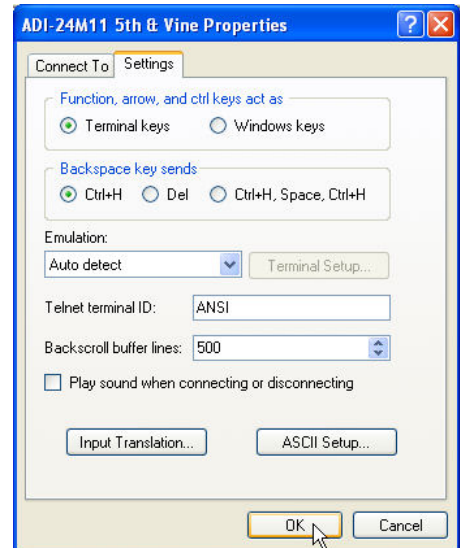

FIGURE 19

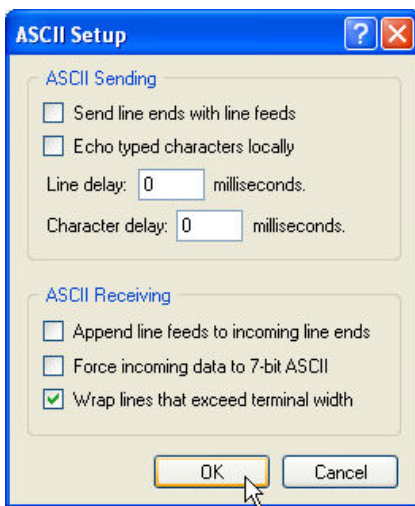

FIGURE 20

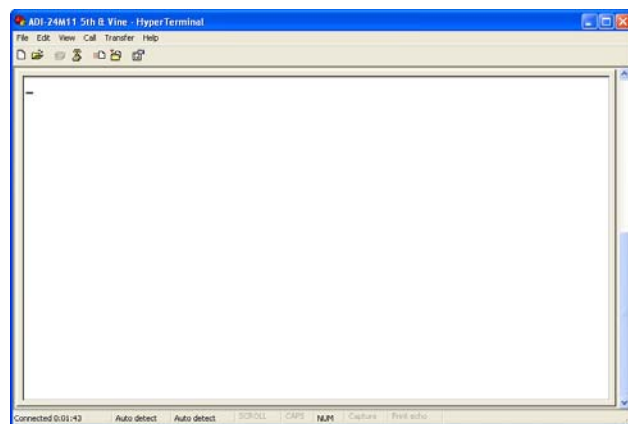

FIGURE 21

8.2.2 HyperTerminal Log File

HyperTerminal is capable of logging the terminal session in a text file for later viewing or data transfer. To initiate a log file use the following steps.

1. From the **Terminal Interface** window click **'Transfer'** menu then click **'Capture Text'**. See Figure 22 below.
2. The **'Capture Text'** window appears see Figure 23 below. Enter a path and file name appropriate for the BBS unit. The example uses a date and intersection to designate the BBS. When finished click the **Start** button. The communication session will now be logged. The file will be saved automatically upon exit of HyperTerminal.

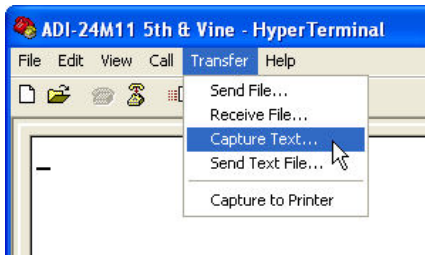

FIGURE 22

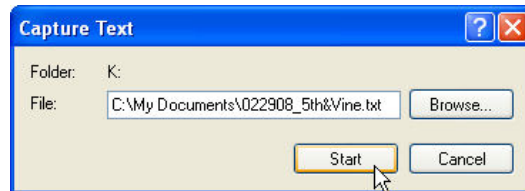

FIGURE 23

8.2.3 Other Terminal Emulation Setups

If another terminal emulation software package is used, the parameters in Table 4 will be needed to communicate with the BBS unit.

TABLE 4: Terminal Emulation Setting

Emulation Type	VT100 or compatible
Duplex Mode	Half Duplex
Xon/Xoff Flow Control	ON
RTS/CTS Flow Control	OFF
Line Wrap	ON
Screen Scroll	ON
CR Translation	CR
Back Space	N/A
Break Length	N/A
Inquiry	NA
Handshaking	Software
Baud Rate	9600
Data Format	8 Data, No Parity, 1 Stop Bit

8.3 Using the BBS Communication Interface

The Dimensions BBS Communications Interface, for simplicity, is broken down into three menu screens (System Status, Configuration, and System). These menus will allow you to acquire status information, configure the BBS, view/print/save the Event Log, and view/print/save the Self Test Report.

```

BBS 9600 - HyperTerminal
File Edit View Call Transfer Help
[Icons]

SYSTEM STATUS / MAIN MENU
-----
Sensata Technologies - BBS Interface                                05/13/11 10:35
MODEL: S/N: LOCATION: VER: v0.7.3.19
ALARMS/FAULTS: NO ACTIVE ALARMS/FAULTS
BBS MODE: STANDBY CHARGER MODE: FLOAT
-----
(c) CONFIGURATION (s) SYSTEM (r) REFRESH (e) EVENT LOG-----
(7) RESET ALL COUNTERS (t) SELF TEST REPORT
-----
SENSE TYPE: BuckBoost BATT CAP/VOLTS/TEMP:100%/27.0V/24.9C
TRANSFER POINTS: 80/160 LINE INPUT AC: 120.7V / 59.9Hz
OUTAGES CUR/TOT(1=R): 157/157 OUTPUT AC: 120.7V / 60.0Hz / 0.0A
RUN TIME CUR/TOT(2=R): 1:36/ 1:36 OUTPUT POWER: 0W
BUCK COUNT CUR/TOT(3=R): 1/ 1 CHARGER DC AMPS: 0.0A
BUCK TIME CUR/TOT(4=R): 0:00/ 0:00 LOW BATT. RLY. : 40%
BOOST COUNT CUR/TOT(5=R): 1/ 1 TIMER RLY. TIME, min.: 120
BOOST TIME CUR/TOT(6=R): 0:00/ 0:00 TOD TIME: DISABLED/00:00-00:06
EXTERNAL FAN: OFF
-----
RLY C1: OB OFF RLY C4: LB OFF
RLY C2: OB OFF RLY C5: TR OFF
RLY C3: LB OFF RLY C6: TR OFF
-----
==> _

```

```

BBS 9600 - HyperTerminal
File Edit View Call Transfer Help
[Icons]

CONFIGURATION MENU
-----
Sensata Technologies - BBS Interface                                05/13/11 10:36
MODEL: S/N: LOCATION: VER: v0.7.3.19
ALARMS/FAULTS: NO ACTIVE ALARMS/FAULTS
BBS MODE: STANDBY CHARGER MODE: FLOAT
+- (m) MAIN/STATUS (s) SYSTEM (r) REFRESH (e) EVENT LOG (t) SELF TEST REPORT +-
-----
(1) BATTERY TYPE AGM (13) SELF TEST: ENABLED
(2) SENSE TYPE BuckBoost (14) SELF TEST START: 00:14
(3) LINE QUALIFY TIME: 5 Sec. (15) SELF TEST DAYS: 1st and 15th
(4) LOW BATT. RELAY %: 40 (16) SELF TEST DURATION, min.: 1
(5) TIMER RLY. TIME, min.: 120 (17) SELF TEST NOW
(6,7) TIME OF DAY: 00:00-06:00 Self Test Available
(8) TIME OF DAY ENABLE: DISABLED (18,19) TRANSFER PTS. NORM: 100/130
(9) FAN ON DEG. C (EXT.): 25C (20,21) TRANSFER PTS. GEN: 95/134
(10) FAN ENABLE: DISABLED (22) Temp Scale: DegC
(11,12)TEMP. ALARM L/H: -40C/ 75C
-----
(30)RLY C1: OB (30)RLY C4: LB
(30)RLY C2: OB (30)RLY C5: TR
(30)RLY C3: LB (30)RLY C6: TR
-----
==>

```

To make a change in configuration, type in the number of the desired field to change and then press enter. Some fields will toggle their values and others will take you to an entry screen to enter your data.

BBS 9600 - HyperTerminal

File Edit View Call Transfer Help

SYSTEM MENU

Sensata Technologies - BBS Interface 05/13/11 10:37
MODEL: S/N: LOCATION: VER: v0.7.3.19
ALARMS/FAULTS: NO ACTIVE ALARMS/FAULTS
BBS MODE: STANDBY CHARGER MODE: FLOAT

(m) MAIN/STATUS (c) CONFIGURATION

(1) TIME:	10:37
(2) D-LIGHT SAVINGS:	NO
(3) DATE:	05/13/11
MODEL:	
SERIAL:	
(4) DATE INSTALLED:	01/01/99
(5) LOCATION:	

==>

Connected 0:04:16 Auto detect 9600 8-N-1 SCROLL CAPS NUM Capture Print echo

9.0 Maintenance



*To prevent current being withdrawn from the batteries that may result in battery damage the DC Breaker **must be** switched “Off” if the Manual Bypass Switch is to be in the “Bypass Mode” position for an extended period of time.*

9.1 Preventive Maintenance:

9.1.1 BBS Module Maintenance:

- The BBS module was designed to be maintenance-free. There are no serviceable parts inside the unit.
- Clean the cover of the BBS as needed using a damp cloth or nonabrasive cleanser.



Do not use ACETONE-BASE cleaning solutions. Keep cleaning solutions out of the electrical receptacles on this device.

9.1.2 Battery Maintenance:

- The BBS uses sealed maintenance-free batteries. Proper charging and limited cycling along with a proper battery environment will ensure a long battery life.



Servicing of batteries should be performed or supervised by authorized personnel at least four times a year.



A battery can present a risk of electrical shock and high short circuit current.

- Before proceeding with maintenance, review battery system drawings.
- Clean and tighten battery connections.
- Replace batteries when conductance tests indicate 30% to 40% deterioration from the original value. Use a battery conductance tester to create a log of the health of your batteries.
- When replacing batteries, use the same model number and type batteries. Batteries should be replaced in complete sets.

9.2 Alarms & Faults

Alarm List:

temp. alarm low*	The temperature is equal to or over the preset value.
temp. alarm high*	The temperature is equal to or under the preset value.
check battery*	There is a problem with the battery system.
overload*	The load is drawing more current than the BBS rated power.
output volt. Low*	The inverter output voltage is below 110 volts.
ac line freq. l or h*	The AC Line input frequency is outside of 60Hz +/- 3.0Hz.
dbt test fail*	The disconnected battery test has failed. Check the batteries and cabling. This alarm will clear with a passed test or power cycle.

Fault List:

PROBE FLT – CHGRDISABL*	The temperature compensation cable is disconnected or bad. This will shut down the charger.
SELF TEST FAIL	The Self Test Failed. See log for reason why.
BATT. LOW CUT OFF*	The battery voltage has dropped to the protective low cutoff point.
BATT. VOLT. HIGH	The battery voltage is higher than what is safe for the battery.
OUTPUT VOLT. HIGH	The inverter AC output voltage is over 135 volts.
BBS. TEMP. HIGH*	The BBS internal temperature is too high.
OVERLOAD SHUTDOWN	The inverter is shutting down due to overload
BBS FAILURE	Inverter or Charger failure.

Note: Faults or Alarms with an “*” will self reset after the condition has cleared. Faults and Alarms that do not self reset need to have the power cycled on the BBS (AC&DC).